

8x8x16 Regular Fence Column Block

Product No: 801048100

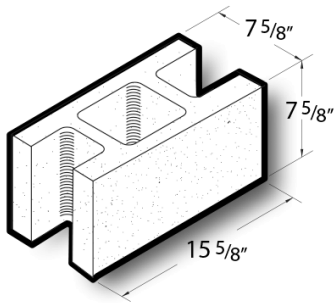

8x8x16 Regular Fence Column Block is an ideal solution for building fence wall with concrete masonry units that exceed ASTM C90 standard specifications in all weight classifications. [Contact](#) your Best Block representative for special requests and additional options.

- Available in medium, normal, and light-weight varieties
- Competitively priced and produced locally.
- Concrete blocks are naturally fire-resistant, highly durable, and its mass creates energy-efficient wall systems.
- Item weight and pallet count may vary by location.
- [Contact](#) your Best Block representative for more information.

Unit(s)

Product No.	801048100
Weight/Block:	37
Block/Pallet:	72
Pallet Weight:	2724